

Section 9 Liquid Level Controls

Liquid Level Controls

Selection Guide	9.3
-----------------------	-----

Open Board



- LLC1 9.4
- LLC2 9.12

Octal Plug-in



- LLC4 9.6
- LLC5 9.14

Low Level Cut Off



- LLC8 9.8
- LLC6 9.10

DIN Rail Mounting Liquid Level Controls



- CM-ENE
 - CM-ENS
 - CM-ENS_{Up/Dn}
 - CM-ENN
 - CM-ENN_{Up/Dn}
- Product pages are not included in this catalog.
Go to: www.ssac.com/s9.pdf
Click on the Product Name (ie: CT-ENE) to open the catalog page.
[Adobe Acrobat Reader is required]

Alternating Relays



- ARP 9.16

DIN Rail Mounting Isolation Monitors



- CM-IWN-AC
 - CM-IWN-DC
 - C 558.01
 - C 558.02
 - C 558.03
- Product pages are not included in this catalog.
Go to: www.ssac.com/s9.pdf
Click on the Product Name (ie: CT-IWN-AC) to open the catalog page.
[Adobe Acrobat Reader is required]

Liquid Level Controls Selection Guide

For detailed product specifications, refer to catalog pages.

Open PC Board



Monitor and control conductive liquid levels when filling or emptying tanks. Low cost open board design.

Plug-in Package



Monitor and control conductive liquid levels when filling or emptying tanks. Convenient plug-in packaging.

Alternating Relays & Duplexers







Provides equal run time for two loads. Automatically changes lead load upon the opening of the control switch input. Industry standard wiring.

Series	LLC1	LLC2	LLC8	LLC4	LLC5	LLC6	ARP_1	ARP_2	ARP_3
Functions and Features Page	9.4	9.12	9.8	9.6	9.14	9.10	9.16	9.16	9.16
General Features									
Single Probe & Common	•		•	•		•			
Dual Probe & Common		•			•				
DIN Rail Mounting				w/socket	w/socket	w/socket	w/socket	w/socket	w/socket
Surface Mounting	•	•	•	w/socket	w/socket	w/socket	w/socket	w/socket	w/socket
Plug-In Socket Required				8 pin	8 pin	11 pin	8 pin	11 pin	8 pin
Screw Terminals		•		w/socket	w/socket	w/socket	w/socket	w/socket	w/socket
Quick Connects	•	•	•						
Output Form									
Isolated Output	SPDT	SPDT	SPDT	SPDT	SPDT		SPDT	DPDT	
Non-Isolated Output	SPST					SPDT			DPDT-X
Sensing Range									
6K ... 20K Ω									
1K or 5K ... 100K Ω		•			•				
1K or 5K ... 250K Ω	•		•	•		•			
250 Ω ... 500K Ω									
Set Point: A=Adjustable; F=Fixed	A or F	A or F	F	A or F	A or F	F			
Trip Delay Fixed	1...60 s		1...60 s	1...60 s		1...60 s			
Probe Voltage									
12 V AC	•	•	•	•	•	•			
20 V AC or 30 V AC									
Logic Type									
Drain/Emptying	•	•		•	•				
Fill	•	•		•	•				
Low Level Cut Off			•			•			
Alternating/Duplexing							•	•	•
Input Voltage									
24 V AC	•	•	•	•	•	•	•	•	•
24 ... 240 V AC/DC									
110 ... 130 V AC	•	•	•	•	•	•	•	•	•
220 ... 240 V AC	•	•	•	•	•	•	•	•	•
380 ... 415 V AC									
Indicator LED (s)									
Output(s) ON/OFF			•		•	•	Loads A/B	Loads A/B	Loads A/B
Supply ON/OFF									
Dimensions									
	in	2.75 x 3.5 x ≤2.0	3.0 x 4.0 x 2.0	2.19 x 2.5 x 1.88	1.78 x 2.39 x 2.91 (LLC5 D = 3.30)		1.78 x 2.39 x 3.20		
	mm	69.9 x 88.9 x ≤50.8	76.2 x 101.6 x 50.8	55.6 x 63.5 x 47.8	45.2 x 60.7 x 73.9 (LLC5 D = 83.8)		45.2 x 60.7 x 81.3		

Liquid Level Controls Selection Guide

Liquid level
controls

	DIN Mount 22.5 mm Adjustable		DIN Mount 45 mm Adjustable		DIN Mount 22.5 mm Fixed		Insulation Monitors	
								
	Monitor and control conductive liquid levels when filling or emptying tanks. Thin profile Snap- ON mounting package.		Monitor and control conductive liquid levels when filling or emptying tanks w/time-dependent features.		Monitor and control conductive liquid levels to prevent dry running and overflow.		Monitors the insulation resistance between ungrounded AC/DC systems and ground.	
Series	CM-ENS	CM-ENS UP/DOWN	CM-ENN	CM-ENN UP/DOWN	CM-ENE		CM-IWN C558.03	
Functions and Features	Product pages are not included in this catalog. Go to: www.ssac.com/sg91.pdf . Click on the Product Name (i.e. CM-ENS)							
General Features								
Single Probe & Common					•			
Dual Probe & Common	•	•	•	•	•			
DIN Rail Mounting	•	•	•	•	•		•	
Surface Mounting	w/adaptor	w/adaptor	w/adaptor	w/adaptor	w/adaptor		w/adaptor	
Plug-In Socket Required								
Screw Terminals	•	•	•	•	•		•	
Quick Connects								
Output Form								
Isolated Output (2) = Two N.C. Outputs	SPDT	SPDT	DPDT	(2) & SPDT	SP-NO		SPDT or DPDT	
Non-Isolated Output								
Sensing Range								
6K ... 20K Ω								
1K or 5K ... 100K Ω	•	•		•	•			
1K to 500K Ω							•	
250 Ω ... 500K Ω			•					
Set Point: A=Adjustable; F=Fixed	A	A	A	A	F			
Trip Delay Fixed	250 ms	250 ms	0.1...10s Adj	250 ms	=200 ms			
Probe Voltage								
20 V AC or 30 V AC	•	•	•	•	•			
Logic Type								
Drain/Emptying	•	Selectable	•	Selectable	MAX			
Fill	•	Selectable	•	Selectable	MIN			
Alarm Levels				Low & High				
Alternating/Duplexing								
Set Point Control								
24 V AC	•	•	•	•	•			
24 ... 240 V AC/DC			•				•	
110 ... 130 V AC	•	•	•	•	•		•	
220 ... 240 V AC	•	•	•	•	•		•	
380 ... 415 V AC	•		•	•				
Indicator LED (s)								
Output(s) ON/OFF	•	•	•	•	•		•	
Supply ON/OFF	•	•	•	•			•	
Dimensions								
	in	0.89 x 3.07 x ≤ 3.98		1.77 x 3.07 x ≤ 3.98		0.89 x 3.07 x ≤ 3.09		1.77 x 3.07 x ≤ 3.98
	mm	22.5 x 78 x ≤ 101		45 x 78 x ≤ 101		22.5 x 78 x 78.5		45 x 78 x ≤ 101

Liquid Level Control

LLC1 Series

Single Probe



- Single Probe Level Control for Conductive Liquids
- Isolated AC Voltage on the Probes
- Adjustable or Fixed Sensing up to 250KΩ
- Fill or Drain Operation Available
- 24, 120, or 230 V AC Models are Available
- 10 A SPDT Isolated & SPST Non-Isolated Contacts

Approvals:

Accessories



Electrode
P/N: **PHST-38QTN**



Female quick connect
P/Ns:
P1015-13 (AWG 10/12)
P1015-64 (AWG 14/16)
P1015-14 (AWG 18/22)

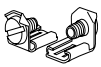

Quick connect to screw adaptor
P/N: **P1015-18**

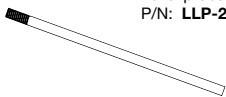

Level probe
P/N: **LLP-24**

See accessory pages for specifications.

Description

The LLC1 Series is a single probe conductive liquid level control designed for OEM equipment and commercial appliances. This device may be ordered in one of two modes: Fill or Drain. A factory fixed time delay (1-60 s) prevents rapid cycling of the output relay. On adjustable units, the sensitivity adjustment allows accurate level sensing while ignoring foaming agents and floating debris. Transformer isolated 12 V AC is provided at the probe to prevent electrolysis. A trickle current of less than 1 mA determines the presence or absence of liquid between the probe and common. The LLC1 Series printed circuit board is conformal coated to resist moisture and corrosion.

Operation

Drain: When the liquid level rises and touches the probe, a fixed time delay begins. This time delay prevents rapid cycling of the output relay and its load. At the end of the time delay, the output relay energizes and remains energized until the liquid level falls below the probe. The output relay then de-energizes and remains de-energized until the liquid again touches the probe.

Fill: When the liquid level falls below the probe, a fixed time delay begins. This time delay prevents rapid cycling of the output relay and its load. At the end of the time delay, the output relay energizes and remains energized until the liquid level rises and touches the probe. The output relay then de-energizes and remains de-energized until the liquid level again falls below the probe.

Connection

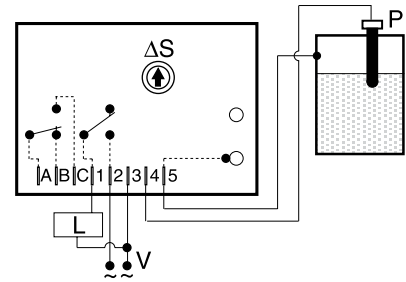

Connect common to conductive tank or an additional probe as required. Contacts A, B, & C are isolated.

P = Probe L = Load V = Voltage
ΔS = Sensitivity Adjustment

Ordering Table

LLC1 Series	X Input	X Operation	X Time Delay	X Sense Resistance	X Mounting
	-2 - 24 V AC	-A - Drain	Specify fixed delay (1 ... 60) secs. in 1 s increments	-A - Adjustable	Blank - Surface Mount
	-4 - 120 V AC	-B - Fill		-F - Fixed	-X - 0.50 in. nylon standoffs (three)
	-6 - 230 V AC			Specify fixed resistance (1 ... 250) in 1KΩ increments	

Example P/N: **LLC14A7A** Fixed – **LLC14B1F100X**

Liquid Level Control

LLC1 Series

Single Probe

Liquid level controls

Technical Data

Control		
Type		ON/OFF (Single Level) Resistance sensor with built-in time delay to prevent rapid cycling
Sense Voltage		12 V AC at probe terminals
Sense Resistance		Factory fixed or adjustable to 250K Ω
Sense Resistance Tolerance		Adjustable - guaranteed range Factory fixed +/-10%
Input		
Voltage		24, 120, or 230 V AC
Tolerance	24 V AC	-15% ... +20%
	120 & 230 V AC	-20% ... +10%
Frequency		50 ... 60 Hz
Output		
Type		Electromechanical relay
Form		SPST non-isolated & SPDT isolated contacts
Rating		10 A resistive at 120/240 V AC & 28 V DC; 1/3 hp at 120/240 V AC
Life		Mechanical - 1 x 10 ⁷ ; Electrical - 1 x 10 ⁵
Protection		
Isolation Voltage		\geq 1500 V RMS between input, output, & probe
Mechanical		
Mounting		Surface mount to probe COMMON with two #6 (M3.5 x 0.6) screws or 0.50 inch (12.7 mm) nylon standoffs with three #6 (M3.5 x 0.6) screws (use Terminal 5 for probe COMMON)
Termination		0.25 in. (6.35 mm) male quick connect terminals
Package (Open Board)		3.5 x 2.75 x 2 in. (88.9 x 69.9 x 50.8 mm)
Environmental		
Operating / Storage Temperature		-20°C ... +55°C / -40°C ... +80°C
Protection		Printed circuit board is conformal coated to resist moisture and corrosion
Weight		\approx 8.7 oz (247 g)

Mechanical View

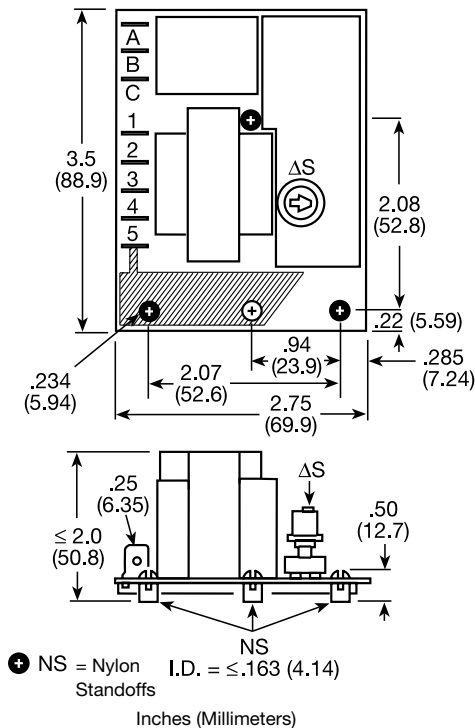

Liquid Level Control

LLC4 Series

Single Probe



10 YEAR WARRANTY

- Single Probe Level Control for Conductive Liquids
- Adjustable or Fixed Sensing up to 250KΩ
- Fill or Drain Operation Available
- 24, 120, or 230 V AC Models are Available
- Isolated AC Voltage on the Probes
- 4 A Resistive SPDT Isolated Contacts

Approvals:

Accessories

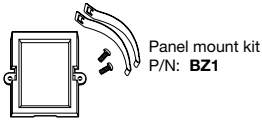

Panel mount kit
P/N: **BZ1**

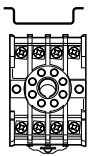

Octal
8 pin socket
P/N: **NDS-8**

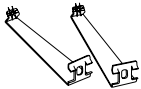

Hold down clips
P/N: **PSC8**



Electrode
P/N: **PHST-38QTN**

Level probe P/N: **LLP-24**

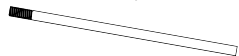

See accessory pages for specifications.

Description

The LLC4 combines resistance sensing circuitry with solid state timing to provide single probe level maintenance. On adjustable units, the sensitivity adjustment allows accurate level sensing while ignoring foaming agents and floating debris. Transformer isolated 12 V AC is provided at the probe to prevent electrolysis. A trickle current of less than 1 mA determines the presence or absence of liquid between the probe and common. The LLC4 Series can be used with many types of low voltage (resistance changing) transducers to perform other control functions like temperature limit control, photo limit control, condensation sensing, and ice sensing.

Operation

Drain (Pump Down Mode): When the liquid level rises and touches the probe, a fixed time delay begins. This time delay prevents rapid cycling of the output relay and its load. At the end of the time delay, the output relay energizes and remains energized until the liquid level falls below the probe. The output relay then de-energizes and remains de-energized until the liquid again touches the probe.

Fill (Pump Up Mode): When the liquid level falls below the probe, a fixed time delay begins. This time delay prevents rapid cycling of the output relay and its load. At the end of the time delay, the output relay energizes and remains energized until the liquid level rises and touches the probe. The output relay then de-energizes and remains de-energized until the liquid level again falls below the probe.

Connection

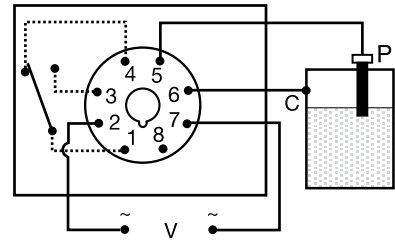

Relay contacts are isolated. Dashed lines are internal connections.

Connect common to conductive tank. Additional probe is necessary for non-conductive or insulated tanks.

P = Probe C = Probe Common V = Voltage

Ordering Table

LLC4 Series	X Input	X Operation	X Time Delay (Seconds)	X Sense Resistance
	-2 - 24 V AC	-A - Drain	Specify fixed delay (1 ... 60) secs. in 1 s increments	-A - Adjustable
	-4 - 120 V AC	-B - Fill		-F - Fixed
	-6 - 230 V AC			Specify fixed resistance (1 ... 250) in 1K Ω increments

Example P/N: **LLC44A1A** Fixed – **LLC46B5F50**

Liquid Level Control

LLC4 Series

Single Probe



Technical Data

Control Type Sense Voltage Sense Resistance Sense Resistance Tolerance	ON/OFF (Single Level) Resistance sensor with built-in time delay to prevent rapid cycling 12 V AC at probe terminals Factory fixed or adjustable to 250K Ω Adjustable - guaranteed range Factory fixed +/-10%
Input Voltage Tolerance Frequency	24, 120, or 230 V AC -15% ... +20% -20% ... +10% 50 ... 60 Hz
Output Type Form Rating	Electromechanical relay Isolated single pole double throw (SPDT) contacts 4 A resistive at 240 V AC; 1/10 hp at 240 V AC
Protection Surge Isolation Voltage	IEEE C62.41-1991 Level A ≥ 1500 V RMS between input, output, & probe
Mechanical Mounting Termination Package	Plug-in socket 8 Pin plug-in 2.91 x 2.39 x 1.78 in. (73.9 x 60.7 x 45.2 mm)
Environmental Operating Temperature Storage Temperature Weight	-20°C ... +60°C -40°C ... +80°C $\cong 6$ oz (170 g)

Mechanical View

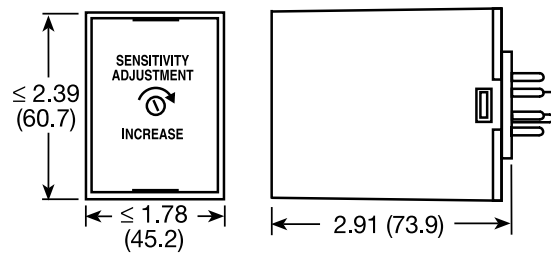

Inches (Millimeters)

Low Level Cutoff LLC8 Series Liquid Level Control



- Designed for Low Level Cutoff Protection
- Energized on Wet Probe
- Fixed Time Delay of 1 ... 60 s
- Fixed Sense Resistance of 5K ... 250K Ω
- 24, 120, or 230 V AC Input Voltages Available
- Isolated 10 A, SPDT Relay Contacts

Approvals:

Accessories



Electrode
P/N: PHST-38QTN



Female quick connect
P/Ns:
P1015-13 (AWG 10/12)
P1015-64 (AWG 14/16)
P1015-14 (AWG 18/22)

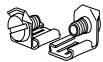

Quick connect to screw adaptor
P/N: P1015-18

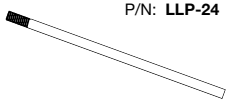

Level probe
P/N: LLP-24

See accessory pages for specifications.

Description

The LLC8 Series is a low cost single probe conductive liquid level control designed for low liquid level cutoff protection. It offers a factory fixed time delay of 1 to 60 s and is available for input voltages of 24, 120, or 230 V AC. LED indicator illuminates whenever the LLC8's isolated 10 A SPDT output relay is energized. Sense resistance is fixed from 5K to 250K Ω. Available with manual/automatic reset or a special manual reset with a power outage feature that auto resets the unit when power is restored and the water level is acceptable. 24 and 120 V AC units are UL recognized as limit switches under UL353 (230 V AC units are UL 508) and CSA certified under Standard 14.

Operation

Automatic Reset (Reset switch not connected):

When liquid rises to low level cutoff probe, output relay and LED indicator energize. When liquid falls below low level cutoff probe, output relay and LED indicator de-energize after a fixed time delay.

Manual Reset (Reset switch connected): When the liquid level falls below low level probe, the output relay and LED de-energize after a fixed time delay. When the liquid level rises to low level probe, the output relay and LED indicator remain de-energized until the N.C. manual reset switch is opened; then they energize immediately.

Power Outage Manual Reset (Reset switch connected): A power outage causes the output relay and LED indicator to de-energize. Upon restoration of power, if the liquid is touching the low level probe, the output relay and LED indicator will re-energize. If the liquid level is below the low level probe, the output relay and LED indicator remain de-energized until the N.C. reset switch is opened.

Connection

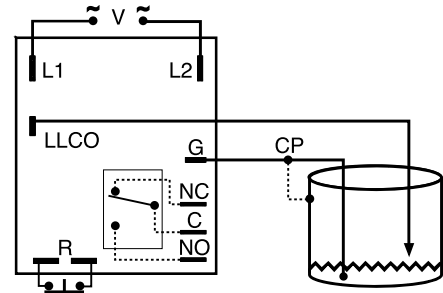

Relay contacts are isolated. Dashed lines are internal connections.

Connect common to conductive tank. Additional probe is necessary for non-conductive or insulated tanks.

V = Voltage LLCO = Low Level Probe
G or CP = Ground or Common (Reference) Probe
R = Optional NC Reset Switch (not included)
NO = Normally Open NC = Normally Closed
C = Common or Transfer Contact

Ordering Table

LLC8 Series	X Input	X Time Delay (Fixed)	X Sense Resistance	X Reset
	-2 - 24 V AC	Specify Fixed Delay	-F - Fixed	-M - Manual/Automatic Reset
	-4 - 120 V AC	In Seconds	Specify Fixed Resistance	-P - Power Outage Manual Reset
	-6 - 230 V AC	[1 ... 60] In 1 s Increments	In Kilohms [5 ... 250] in 1K increments	

Example P/N: LLC8410F25M, LLC8620F100P

Low Level Cutoff LLC8 Series Liquid Level Control

Liquid level
controls

Technical Data

Control		
Type		Resistance sensing for conductive liquids with time delay
Sense Voltage		12 V AC nominal at probe terminals
Sense Resistance		5K ... 250K Ω fixed
Sense Resistance Tolerance		+/-10%
Time Delay		
Tolerance		+/-20%
Repeat Accuracy		+/-10%
Time Delay vs. Temperature & Voltage		+/-10%
Power Outage Reset Delay		≤ 1 s
Input		
Voltage		24, 120, or 230 V AC
Tolerance	24 V AC	-15% ... +20%
	120 or 230 V AC	-20% ... +10%
Frequency		50 ... 60 Hz
Output		
Type		Electromechanical relay
Form		Isolated single pole double throw (SPDT)
Rating		10 A resistive at 120/240 V AC; 1/4 hp at 125 V AC; 1/2 hp at 250 V AC
Protection		
Surge		IEEE C62.41-1991 Level A
Isolation Voltage		≥ 2500 V RMS input to output terminals
Mechanical		
Mounting		0.5 in. (12.7 mm) x .187 (4.76 mm) dia. nylon standoffs (3)
Termination	Electrical	0.25 in. (6.35 mm) male quick connect terminals
	Reset Switch & Probe(s)	0.187 x 0.03 in. (4.75 x 0.76 mm) male quick connect terminals
Environmental		
Operating Temperature		-40°C ... +60°C
Storage Temperature		-40°C ... +80°C
Coating		Printed circuit board is conformal coated to resist moisture & corrosion
Humidity		95% relative, non-condensing
Weight		≈ 5 oz (141.7 g)

Mechanical View

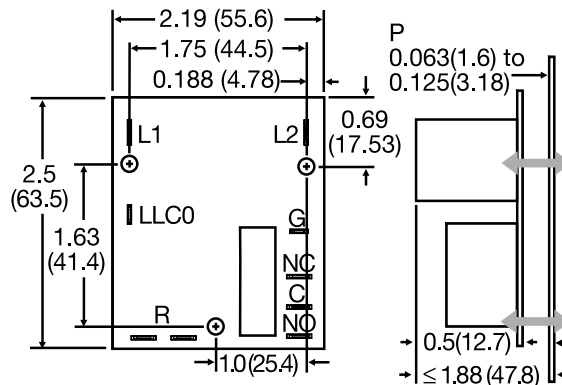

Inches (Millimeters)

P = User supplied mounting panel thickness

LLC82B01 06.30.04

Low Level Cutoff LLC6 Series Liquid Level Control



10 YEAR WARRANTY

- Designed for Low Level Cutoff Protection
- Energized on Wet Probe
- Fixed Time Delay of 1 ... 60 s
- Sense Resistance of 5K ... 250K Ω
- 24, 120, or 230 V AC Input Voltage Available
- 10 A, SPDT Relay Contacts

Approvals:

Accessories

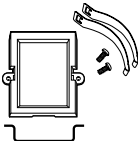

Panel mount kit
P/N: **BZ1**

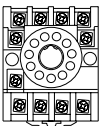

11-pin socket
P/N: **NDS-11**

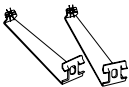

Hold down clips
P/N: **PSC11**



Electrode
P/N: **PHST-38QTN**



Level probe
P/N: **LLP-24**

See accessory pages for specifications.

Description

The LLC6 Series is a plug-in single probe conductive liquid level control designed for low liquid level cutoff protection. It offers a factory fixed time delay of 1 to 60 s and is available in input voltages of 24, 120, or 230 V AC. LED indicator illuminates whenever the LLC6's 10 A SPDT output relay is energized. Available with automatic/manual reset or a special manual reset with power outage feature, which auto resets the unit when power is restored and the water level is acceptable. 24 V AC and 120 V AC units are recognized as limit switches under UL353 (230 V AC units are UL508) and CSA certified under Standard 14.

Operation

Automatic Reset

(Reset terminals not connected):

When liquid rises to the low level cutoff probe, the output relay and the LED indicator energize. When the liquid falls below low level cutoff probe, the output relay and the LED indicator de-energize after a fixed time delay.

Manual Reset (Reset switch connected): When the liquid level falls below the low level probe, the output relay and LED de-energize after a fixed time delay. When the liquid level rises to the low level probe, the output relay and LED indicator remain de-energized until the manual reset switch is opened; then they energize immediately.

Power Outage Manual Reset (Reset switch connected): A power outage causes the output relay and LED indicator to de-energize. Upon restoration of power, if the liquid level is above the low level probe, the output relay and LED indicator will re-energize. If the liquid level is below the low level probe, the output relay and LED indicator remain de-energized until the Normally Closed (NC) reset switch is opened.

Connection

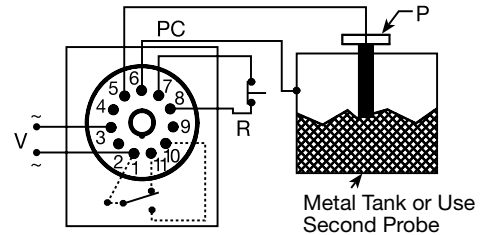

Dashed lines are internal connections.

Connect common to conductive tank. Additional probe is necessary for non-conductive or insulated tanks.

PC = Probe Common P = Probe V = Voltage
R = Optional NC Reset Switch

Ordering Table

LLC6 Series	X Input	X Time Delay (Fixed)	X Sense Resistance	X Reset
	-2 - 24 V AC	-Specify Fixed Delay In Seconds [1 ... 60]	- Fixed Specify Fixed Resistance In Kilohms [5 ... 250] In 1 K increments	-M - Manual/Automatic Reset -P - Power Outage Manual Reset
	-4 - 120 V AC			
	-6 - 230 V AC			

Example P/N: **LLC6410F25M, LLC6640F100P**

Low Level Cutoff

LLC6 Series

Liquid Level Control

Liquid level controls

Technical Data

Control		
Type		ON/OFF (Single Level) Resistance sensor with built-in time delay to prevent rapid cycling
Sense Voltage		12 V AC nominal at probe terminals
Sense Resistance		5K ... 250K Ω factory fixed
Sense Resistance Tolerance		Fixed +/-10%
Time Delay		
Range		1 ... 60 s in 1 s increments
Tolerance		+/-20%
Repeat Accuracy		+/-10%
Time Delay vs. Temperature & Voltage		+/-10%
Power Outage Reset Delay		≤ 1 s
Input		
Voltage		24, 120, or 230 V AC
Tolerance	24 V AC	+20% ... -15%
	120 or 230 V AC	+10% ... -20%
Frequency		50 ... 60 Hz
Output		
Type		Electromechanical relay
Form		Non-isolated (SPDT) contacts
Rating		10 A resistive at 240 V AC; 1/4 hp at 125 V AC; 1/2 hp at 250 V AC
Protection		
Surge		IEEE C62.41-1991 Level A
Isolation Voltage		≥ 2500 V RMS between input & output terminals
Mechanical		
Mounting		Plug-in socket
Termination		11 Pin relay type
Package		2.91 x 2.39 x 1.78 in. (73.9 x 60.7 x 45.2 mm)
Environmental		
Operating Temperature		-40°C ... +60°C
Storage Temperature		-40°C ... +80°C
Humidity		95% relative, non-condensing
Weight		$\cong 7.3$ oz (207 g)

Mechanical View

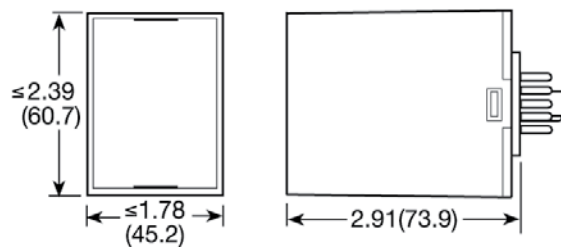

Inches (Millimeters)

Liquid Level Control

LLC2 Series

Dual Probe



- Dual Probe Level Control for Conductive Liquids
- Isolated AC Voltage on the Probes
- Adjustable or Fixed Sensing up to 100K Ω
- Terminal Block or Quick Connect Terminals
- Fill or Drain Operation Available
- 24, 120, or 230 V AC Models are Available
- 10 A SPDT Isolated Contacts

Approvals:

Accessories

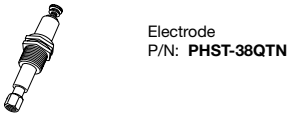

Electrode
P/N: PHST-38QTN



Female quick connect
P/Ns:
P1015-13 (AWG 10/12)
P1015-64 (AWG 14/16)
P1015-14 (AWG 18/22)

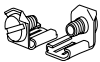

Quick connect to screw adaptor
P/N: P1015-18

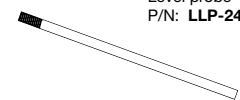

Level probe
P/N: LLP-24

See accessory pages for specifications.

Description

The LLC2 Series is a dual probe conductive liquid level control designed for OEM equipment and commercial appliance applications. Models are available for fill or drain operation. Transformer isolated 12 V AC is provided at the probes to prevent electrolysis. A trickle current of less than 1 mA determines the presence or absence of liquid between the probes and common. On adjustable units, the sensitivity adjustment allows accurate level sensing while ignoring foaming agents and floating debris. The LLC2 Series printed circuit board is conformal coated to resist moisture and corrosion.

Operation

Drain: When the liquid level rises and touches the high probe, the output relay energizes and remains energized until the liquid level falls below the low probe. The output relay then de-energizes and remains de-energized until the liquid again touches the high probe.

Fill: When the liquid level falls below the low probe, the output relay energizes and remains energized until the liquid level rises and touches the high probe. The output relay then de-energizes and remains de-energized until the liquid level again falls below the low probe.

Connection

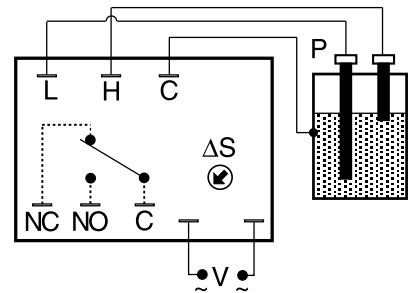

Connect common to conductive tank. Additional probe is necessary for non-conductive or insulated tanks.

V = Voltage L = Low Probe H = High Probe
C = Probe Common Δ S = Sensitivity Adjustment
NC = Normally Closed NO = Normally Open

Ordering Table

LLC2 Series	X Input	X Operation	X Termination	X Sense Resistance	X Mounting Dimension
	-2 - 24 V AC	-A - Drain	-1 - 0.25 Quick Connect	-A - Adjustable to 100K Ω	-N
	-4 - 120 V AC	-B - Fill	-2 - Terminal Block	-F - Fixed	-C
	-6 - 230 V AC			Specify fixed resistance (1 ... 100) in 1K Ω increments	

Example P/N: **LLC26B1AN** Fixed – **LLC26B1F100N**

Liquid Level Control

LLC2 Series

Dual Probe

Liquid level controls

Technical Data

Control			
Type			Resistance sensing for high and low level detection of conductive liquids
Sense Voltage			12 V AC at probe terminals
Sense Resistance			Factory fixed or adjustable to 100K Ω
Sense Resistance Tolerance			Adjustable - guaranteed range Factory fixed +/-10%
Input			
Voltage			24, 120, or 230 V AC
Tolerance	24 V AC		-15% ... +20%
	120 & 230 V AC		-20% ... +10%
Frequency			50 ... 60 Hz
Output			
Type			Electromechanical relay
Form			Isolated single pole double throw (SPDT)
Rating			10 A resistive at 120/240 V AC & 28 V DC; 1/3 hp at 120/240 V AC
Life			Mechanical - 1×10^7 ; Electrical - 1×10^5
Protection			
Isolation Voltage			≥ 1500 V RMS between input, output, & probe
Mechanical			
Mounting			Surface mount with two or four #6 (M3.5 x 0.6) screws
Termination			0.25 in. (6.35 mm) duplex male quick connect terminals Terminal blocks for up to #14 AWG (2.5 mm ²) wire
Package (Open Board)			4 x 3 x 2 in. (101.6 x 76.2 x 50.8 mm)
Environmental			
Operating Temperature			-20°C ... +55°C
Storage Temperature			-40°C ... +80°C
Protection			Printed circuit board is conformal coated to resist moisture and corrosion
Weight			≈ 9 oz (255 g)

Mechanical View

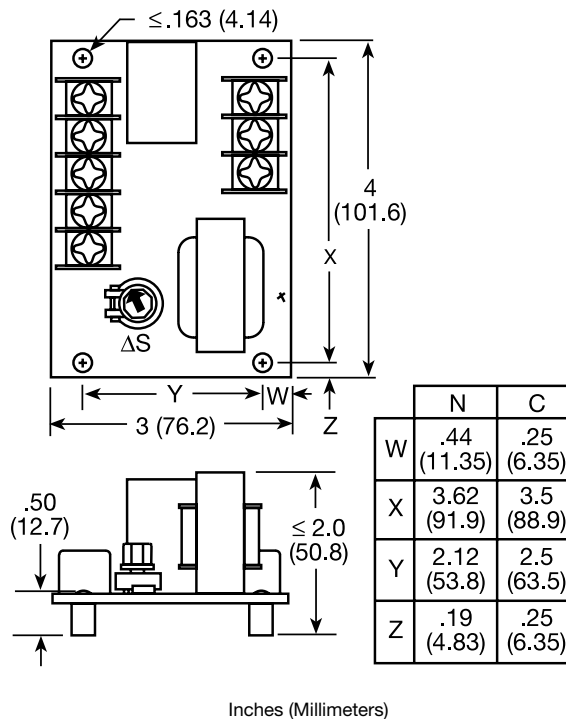

Liquid Level Control

LLC5 Series

Dual Probe



- Dual Probe Level Control for Conductive Liquids
- Onboard Knob or Fixed Sensing up to 100KΩ
- Fill or Drain Operation Available
- LED Indicator Reduces Adjustment Time
- 24, 120, or 230 V AC Models are Available
- 5 A SPDT Isolated Contacts

Approvals:

Accessories

- Panel mount kit
P/N: **BZ1**
- Octal 8 pin socket
P/N: **NDS-8**
- Hold down clips
P/N: **PSC8**
- Electrode
P/N: **WCC-1138**
- Level probe
P/N: **LLP-24**

See accessory pages for specifications.

Description

The LLC5 provides dual probe conductive liquid level control in a convenient octal plug-in package. Models are available for fill or drain operation. Transformer isolated AC voltage on the probes prevents electrolytic plating. Less than 1 mA of current is used to sense the presence of conductive liquid between the probes and common. On adjustable units, the sensitivity adjustment eliminates false tripping caused by floating debris and foaming agents.

Operation

Drain (Pump Down Mode): When the liquid level rises and touches the high level probe, the output relay energizes and remains energized until the liquid level falls below the low level probe. The output relay then de-energizes and remains de-energized until the liquid again touches the high level probe.

Fill (Pump Up Mode): When the liquid level falls below the low level probe, the output relay energizes and remains energized until the liquid level rises and touches the high level probe. The output relay then de-energizes and remains de-energized until the liquid level again falls below the low level probe.

Connection

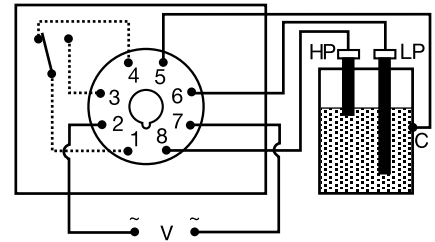

Relay contacts are isolated. Dashed lines are internal connections.

Connect common to conductive tank. Additional probe is necessary for non-conductive or insulated tanks.

HP = High Level Probe LP = Low Level Probe
C = Probe Common V = Voltage

Ordering Table

LLC5 Series	X Input	X Operation	X Sense Resistance	X Connection
	2 - 24 V AC	A - Drain	A - Adjustable	Blank - Standard (#6 Low, #8 High)
	4 - 120 V AC	B - Fill	F - Fixed	S - Reverse (#8 Low, #6 High)
	6 - 230 V AC		Specify fixed resistance (1 ... 100) in 1KΩ increments	

Example P/N: **LLC54AAS** Fixed – **LLC56BF100**

Liquid Level Control

LLC5 Series

Dual Probe

Liquid level controls

Technical Data

Control		
Type		Resistance sensing for high & low level detection of conductive liquids
Sense Voltage		12 V AC at probe terminals
Sense Resistance		Factory fixed or adjustable to 100K Ω
Sense Resistance Tolerance		Adjustable - guaranteed range Factory fixed +/-10%
Input		
Voltage		24, 120, or 230 V AC
Tolerance	24 V AC	-15% ... +20%
	120 & 230 V AC	-20% ... +10%
Frequency		50 ... 60 Hz
Output		
Type		Electromechanical relay
Form		Isolated single pole double throw (SPDT) contacts
Rating		5 A resistive at 240 V AC; 1/10 hp at 240 V AC
Protection		
Isolation Voltage		\geq 1500 V RMS between input, output, & probe
Mechanical		
Mounting		Plug-in socket
Termination		8 Pin plug-in
Environmental		
Operating Temperature		-20°C ... +60°C
Storage Temperature		-40°C ... +80°C
Weight		\cong 6 oz (170 g)

Mechanical View

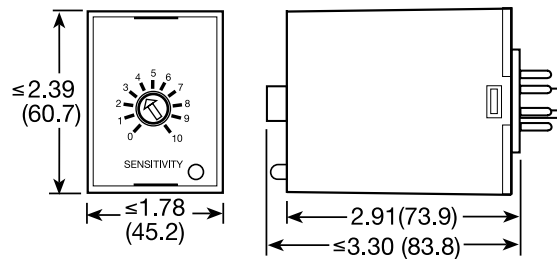

Inches (Millimeters)

Alternating Relay

ARP Series

Motor Duplexor



- Provides Equal Run Time for Two Motors
- Alternating or Electrically Locked Operation
- Low Profile Selection Switch
- 10 A Relay Contacts
- LED Status Indication
- Industry Standard Base Connection

Approvals:

Accessories



Panel mount kit
P/N: **BZ1**

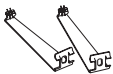

Hold down clips
P/Ns: **PSC8** (NDS-8)
PSC11 (NDS-11)

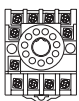

11 pin socket
P/N: **NDS-11**



Octal
8 pin socket
P/N: **NDS-8**

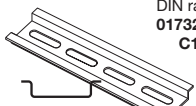

DIN rail P/Ns:
017322005 (Steel)
C103PM (Al)

See accessory pages for specifications.

Description

The ARP Series is used in systems where equal run time for two motors is desirable. The selector switch allows selection of alternation or either load for continuous operation. LED's indicate the status of the output relay. This versatile series may be front panel mounted (BZ1 accessory required) or 35 mm DIN rail mounted with an accessory socket.

Operation

Alternating: When the rotary switch is in the "alternate" position, alternating operation of Load A and Load B occurs upon the opening of the control switch S1. To terminate alternating operation and cause only the selected load to operate, rotate the switch to position "A" to lock Load A or position "B" to lock Load B. The LEDs indicate the status of the internal relay and which load is selected to operate.

Note: Input voltage must be applied at all times for proper alternation. The use of a solid state control switch for S1 may not initiate alternation correctly. S1 voltage must be from the same supply as the unit's input voltage (see connection diagrams). Loss of input voltage resets the unit; Load A becomes the lead load for the next operation.

Connection

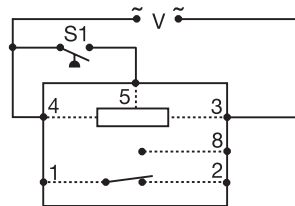

1.
SPDT 8 Pin

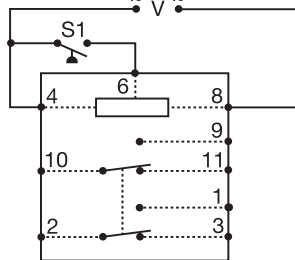

2.
DPDT 11 Pin

Relay contacts in above are isolated.

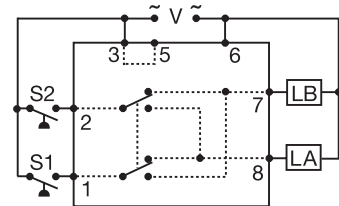

3.
DPDT 8 Pin Cross Wired

Dashed lines are internal connections.

V = Voltage LA = Load A LB = Load B
S1 = Primary Control Switch S2 = Lag Load Switch

Duplexing (Cross Wired): Duplexing models operate the same as alternating relays and when both the Control (S1) and Lag Load (S2) Switches are closed, Load A and Load B energize simultaneously. The DPDT 8-pin, cross wired option, allows extra system load capacity through simultaneous operation of both motors when needed. Relay contacts are not isolated.

Ordering Table

ARP Series	X Input	X Output Form	X Switch Option
	-2 - 24 V AC	-1 - SPDT, 8 Pin	-S - Rotary Switch
	-4 - 120 V AC	-2 - DPDT, 11 Pin	Blank - No Switch
	-6 - 230 V AC	-3 - DPDT, 8 Pin Cross Wired	

Example P/N: **ARP41S, ARP63**

Alternating Relay

ARP Series

Motor Duplexor



Technical Data

Input		
Voltage		24, 120, or 230 V AC
Tolerance	24 V AC	-15% ... +20%
	120 & 230 V AC	-20% ... +10%
Line Frequency		50 ... 60 Hz
Output		
Type		Electromechanical relay
Form		SPDT, or DPDT, or cross wired DPDT
Rating		10 A resistive at 120/240 V AC & 28 V DC; 1/3 hp at 120/240 V AC
Maximum Voltage		250 V AC
Life		Mechanical -- 1×10^7 Electrical -- 1×10^6
Protection		
Isolation Voltage		≥ 1500 V RMS input to output
Mechanical		
Mounting		Plug-in socket
Package		3.2 x 2.39 x 1.78 in. (81.3 x 60.7 x 45.2 mm)
Termination		8 Pin octal or 11 Pin magnal
Environmental		
Operating Temperature		-20°C ... +60°C
Storage Temperature		-30°C ... +85°C
Weight		$\cong 5.6$ oz (159 g)

Mechanical View

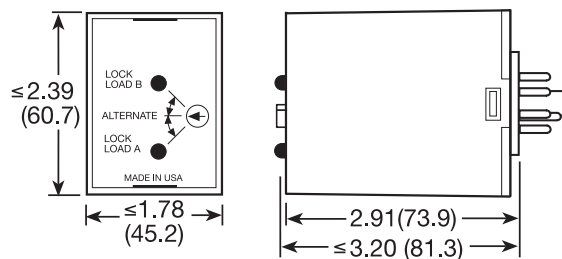

Inches (Millimeters)