

Electronic Overload relays

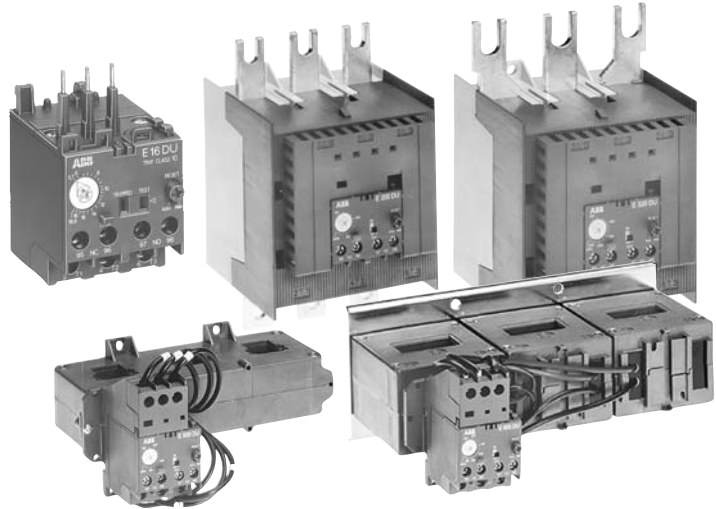

Electronic overload relays E16DU – E800DU

2



Description

- Available for starter construction with A Line contactors and separate panel mounting
- Designed for close couple mounting
- Separate base mounting available for all overload relays
- E16DU Class 10, 20, & 30, factory selectable
- E200DU – E800DU Class 10, 20 & 30, field selectable
- Stop button
- Screwdriver guide holes
- All terminal screws are available from the front
- Single phase and phase unbalance protection
- Isolated alarm circuit (N.O.) contact
- Ambient compensation: -25°C to +70°C (-13°F to +158°F)
- Manual test
- Manual or automatic reset
- Factory calibrated and tested
- Wide adjustment range
- UL File No: E48139
- CSA File No: LR98336

Tripping classes of the thermal overload relays

Standard classes in IEC 947-4-1 are classes: 10 A, 10, 20, 30. The tripping class indicates according to IEC 947-4-1 the maximum tripping time in seconds under specified conditions of test at 7.2 times the setting current and specifies tripping and non tripping times for 1.5 and 7.2 times the setting current. Mostly used class is 10 A.

Abstract from IEC 947-4-1

Tripping class	10 A	10	20	30
Max. tripping time at 1.5 x setting current (warm state) (s)	120	240	480	720
Tripping time at 7.2 x setting current (cold state) (s)	2 – 10	4 – 10	6 – 20	9 – 30
At 1.05 x setting current	no tripping			

General information

Catalog number explanation

2

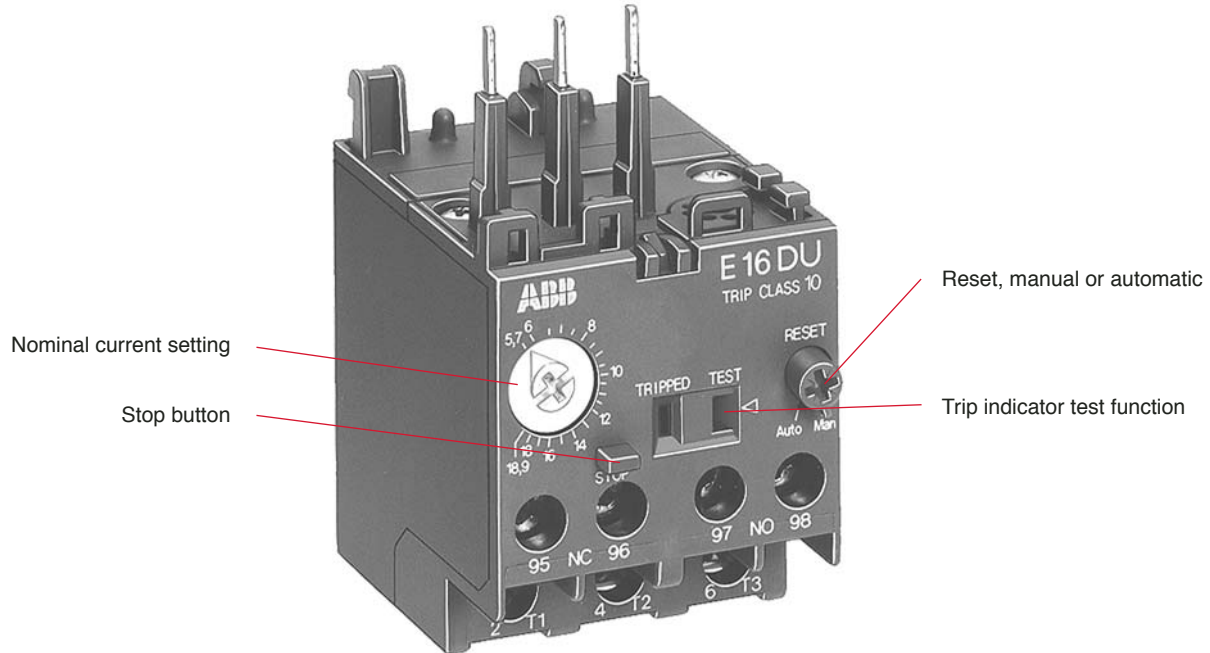

Catalog number explanation

E16DU 1.0 10

Frame size

E16DU
E200DU
E320DU
E500DU
E800DU

Class size

10
20
30

Amp rating

1.0
200
320
500
800

E16DU – E800DU for contactors and mini contactors

Electronic
Overload
relays

2



E16DU



E200DU



E320DU

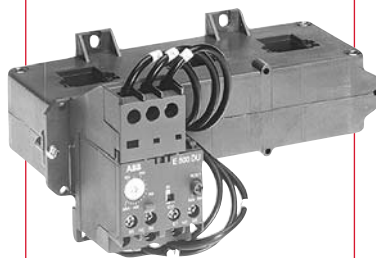

E500DU

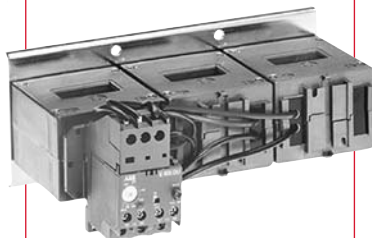

E800DU

E16DU – Tripping Class 10

For contactor	Setting range	Suffix code	Catalog number ①	List price
B/BC6 – B/BC7 A/AE/AL9 – A/AE/AL16	0.1 – 0.32	A1	E16DU0.32-10	\$ 96
	0.3 – 1.0	B1	E16DU1.0-10	
	0.9 – 2.7	C1	E16DU2.7-10	
	2.0 – 6.3	D1	E16DU6.3-10	
	5.7 – 18.9	E1	E16DU18.9-10	

E16DU – Tripping class 20

For contactor	Setting range	Suffix code	Catalog number ①	List price
B/BC6 – B/BC7 A/AE/AL9 – A/AE/AL16	0.1 – 0.32	A2	E16DU0.32-20	\$ 96
	0.3 – 1.0	B2	E16DU1.0-20	
	0.9 – 2.7	C2	E16DU2.7-20	
	2.0 – 6.3	D2	E16DU6.3-20	
	5.7 – 18.9	E2	E16DU18.9-20	

E16DU – Tripping class 30

For contactor	Setting range	Suffix code	Catalog number ①	List price
B/BC6 – B/BC7 A/AE/AL9 – A/AE/AL16	0.1 – 0.32	A3	E16DU0.32-30	\$ 96
	0.3 – 1.0	B3	E16DU1.0-30	
	0.9 – 2.7	C3	E16DU2.7-30	
	2.0 – 6.3	D3	E16DU6.3-30	
	5.7 – 18.9	E3	E16DU18.9-30	

E200DU – E800DU – Tripping class 10, 20 & 30

For contactor	Setting range	Suffix code	Catalog number ①	List price
A/AF145 – A/AF185	65 – 200	E2	E200DU200	\$ 325
A/AF210a – A/AF300	105 – 320	E3	E320DU320	775
AF400 – AF460	170 – 500	E5	E500DU500	865
AF580 – AF750	270 – 800	E8	E800DU800	950

① Not suitable for single-phase motors and direct current (DC) motors.



DB16E



A300 contactor with E320 overload & LT320E terminal shrouds

Mounting kits for direct mounting on contactors AF400 – AF750

For overload relays	On contactor	Catalog number	List price
E500DU	AF400 – AF460 AF400 – AF460 w/reversing kits	DT500/AF460S DT500/AF460L	\$ 395
E800DU	AF580 – AF750 AF580 – AF750 w/reversing kits	DT800/AF750S DT800/AF750L	415

Separate mounting kits

For overload relays	Catalog number	List price
E16DU	DB16E	\$ 15

Lug kits

Wire range	Electronic overload	Catalog number	List price
6 – 250 MCM	E200DU200	ATK185	\$ 45
4 – 400 MCM	E320DU320	ATK300	68
(2) 4 – 500 MCM	E320DU320	ATK300/2	110
(2) 2/0 – 500 MCM	E500DU500	ATK580/2HK	160
(3) 2/0 – 500 MCM	E800DU800	ATK750/3HK	235

Terminal shrouds

For overload relays	Catalog number	List price
E200DU E320DU	LT200E LT320E	\$ 41
E500DU E800DU	LT500E LT800E	52 56

Technical data

E16DU

Electronic
Overload
relays

2

General technical data

Type	E 16 DU	
Standards:	UL508, IEC 60 947-4-1 / IEC 60 947-5-1 EN 60 947-4-1 / EN 60 947-5-1	
Rated insulation voltage U_i	UL / IEC V	600 / 690
Rated operational voltage U_o	UL / IEC V	600 / 690
Impulse withstand voltage U_{imp}	kV	6
Permissible ambient temperature		
- for storage	°C	- 25 to 70
- with compensated operation	°C	- 25 to 70
Climatic resistance acc. to	IEC 68-2-1, IEC 68-2-2, IEC 68-2-14, IEC 68-2-30	
Resistance to shock	Shock duration ms	11
	multiple of g	15
Resistance to vibrations (±1 mm, 10 ... 100 Hz)	multiple of g	5
Mounting	- on contactor - with AB... kit	Direct to contactor's main terminal
Terminal types and connecting capacity of main conductors (on load side) /and auxiliary contacts.		
- Screw terminals (screw size)		M3.5
- with self-disengaging clamping piece		-
- with terminal block		-
- with busbar or cable lugs		-
- Torque	lbin / Nm	7 / 1.0
- connection cross sections		
- copper stranded	AWG / mm ²	10 - 20 / 2X0.75...4
- flexible with connector sleeve	AWG / mm ²	10 - 20 / 2X0.75...4
Protection degree to IEC 947-1/EN 60 947-1	All terminals are safe from finger-touch and touch by the back of the hand in acc. with VDE 0106, Part 100	
Weight	lbs / kg	.33 / .15

Technical data of the current paths

Type	E 16 DU	
Number of paths	3	
Setting ranges	see page 2.21	
Tripping class acc. to IEC 947-4-1/EN 60 947-4-1	see page 2.21	
Operating frequency	Hz	50 and 60
Switching frequency without early tripping	up to 80 ops./h with 40 % continuous duty if starting current not higher than $6 \times I_n$ and starting time not longer than 1s	
Resistance per phase q and heat dissipation per phase in W acc. to max. setting current	see page 2.24	
Required fuses for short circuit protection	see page 2.24	

Tripping characteristics

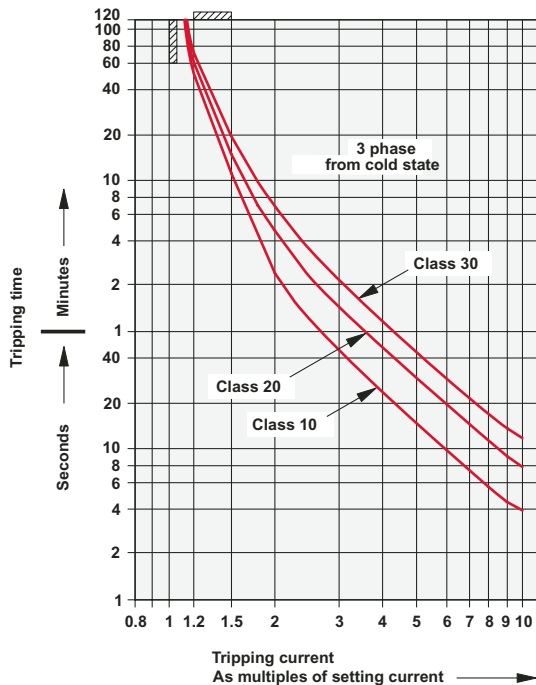

Resistance and power dissipation

Setting range	gL/gG	Short circuit protection		Resistance per phase		Joule losses per phase at upper current setting
		UL/CSA 600V 5kA	UL/CSA 480V/50kA	mΩ	q	
A - A	A	RK5	Class J			
0.1 - 0.32	1	2	2	970	0.97	0.1
0.3 - 1.0	4	2	2	113	0.113	0.11
0.9 - 2.7	10	4	4	14	0.014	0.1
2.0 - 6.3	20	15	15	2.4	0.0024	0.1
5.7 - 18.9	50	30	30	0.8	0.0008	0.29

Technical characteristics of auxiliary contacts

Type	N.C.		N.O.	
	95-96	97-98	95-96	97-98
Rated operational voltage U_e	V		500	
Conventional free air thermal current I_{th}	A		6	
Rated operational current I_{th}				
on AC-15, 230V	A		3	
on AC-15, 400V	A		1.1	
on AC-15, 500V	A		0.9	
on AC-15, 690V	A		0.7	
on DC-13, 24V	A		1.5	
on DC-13, 60V	A		0.5	
on DC-13, 110V	A		0.4	
on DC-13, 220V	A		0.2	
Short circuit protection gG (gf) fuses	A		6	

Technical data

E200DU – E800DU

Electronic
Overload
relays

2

Type	E200DU	E320DU	E500DU	E800DU
Standards: (major international & European standards)	IEC 60947-4-1, EN 60947-4-1, IEC 60947-5-1, EN 60947-5-1			
Approvals, certificates	UL, CSA			
Rated insulation voltage U_i according to IEC 158-1, IEC 60947-4-1	V	690		
Impulse withstand voltage U_{imp} according to IEC 60947-4-1	kV	6		
Permissible ambient temperature • for storage • with compensated operation	°C °C	-25 to +70 -25 to +70		
Climatic resistance according to:	IEC 68-2-1, IEC 68-2-2, IEC 68-2-14, IEC 68-2-30		IEC 68-2-1, IEC 68-2-2, IEC 68-2-30	
Mounting positions	multiple			
Resistance to shock (EN 61373)	Shock duration ms multiple of g	30 5		
Resistance to vibrations (EN 61373)	Category 1, Class B			
Mounting • on contactor • single mounting	2 x M4	2 x M4	2 x M4	2 x M4
Terminal types and connecting capacity of auxiliary contacts • Screw terminals (screw size) • with self-disengaging clamping piece • Torque	Nm	M3.5 1.0		
Connection cross sections – Single core or stranded – Flexible with connector sleeve	mm ² mm ²	2 x 0.75...4 2 x 0.75...4		
Terminal types and connecting capacity of main conductors • Screw terminals (screw size) • with busbar or cable lugs	M8	M10	M10 (bars are accessories)	M12 (bars are accessories)
Protection degree to IEC 947-1/EN 60 947-1	All auxiliary contact terminals are safe from finger touch and touch by the back of the hand in accordance with VDE 0106, Part 100. Main contact terminals are safe from finger touch only with appropriate terminal covers			
Number of current paths	3			
Setting ranges	A	65 – 200	105 – 320	170 – 500 270 – 800
Tripping class according to IEC 947-4-1/EN 60 947-4-1	10, 20, 30			
Operating frequency	Hz	50 and 60 for three phase current only		
Weight	lb/kg	1.72 / .78	1.85 / .84	2.60 / 1.18 9.35 / 4.24

NOTE:• Installation and maintenance have to be performed according to the technical rules, codes and relevant standards by skilled electricians only.

- When using the “Auto” setting, remember that this means the overload will automatically reset after tripping and the motor may restart automatically. This automatic restart could cause harm to personnel and material.
- The overload relay must be exchanged for a new one in case of mechanical and/or electrical damage to prevent harm to personnel and material.

Altitude

Characterizes the place of use. It is expressed in meters above sea level.

Circuits

- **Auxiliary circuit** – all the conductive parts of a contactor designed to be inserted in a different circuit from the main circuit and the contactor control circuits.
- **Control circuit** – all the conductive parts of a contactor (other than the main circuit and the auxiliary circuit) used to control the contactor's closing operation or opening operation or both.
- **Main circuit** – all the conductive parts of a contactor designed to be inserted in the circuit that it controls.

Insulation Class according to NFC 20 040 and VDE 0110

Characterizes adaptation of the devices to ambient temperature and operating conditions. For given clearances and creepage distances, a device will have different insulating voltages depending on insulation classes A, B, C & D. Class C corresponds to most industrial applications. The devices in this catalog belong to Class C.

Coordination of equipment protections during a short circuit

This is the addition upstream of the contactor and thermal overload relay of a short circuit (SCPD) protection device such as a circuit breaker, a fuse with a high breaking capacity or other fuses.

IEC publication 947-4-1 defines coordination Types 1 & 2:

- **Type 1** – Coordination requires that, in the event of a short circuit, the contactor or starter does not endanger persons or installations and will not be able to operate without being repaired or parts being replaced.
- **Type 2** – Coordination requires that, in short circuit conditions, the contactor or starter does not endanger persons or installations and will be able to operate afterwards. The risk of contacts being welded is acceptable. In this case, the manufacturer must stipulate the measures to be taken with respect to maintenance of the equipment.

Rated operational current I_e

Current rated by the manufacturer. It is mainly based on the rated operational voltage U_e , the rated frequency, the utilization category, the rated duty and the type of protective enclosure, if necessary.

Conventional free air thermal current I_{th}

Current that the contactor can withstand in free air for a duty time of 8 hours without the temperature rise of its various parts exceeding the maximum values given by the standard.

Cycle time

Cycle time is the sum of the current flow time and the no-current time for given cycle.

Electrical durability

Number of on-load operations that the contactor is able to carry out; it depends on the utilization category.

Mechanical durability

Number of no-current operations that a contactor is able to carry out.

Load factor

Ratio of the on-load operating time to the total cycle time x 100.

Switching frequency

Number of switching cycles per hour.

Approximate dimensions E16DU – E200DU

E16DU

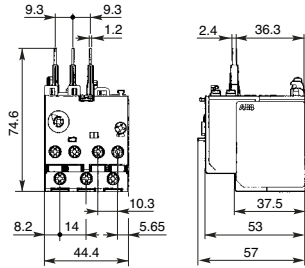

E16DU with DB16E

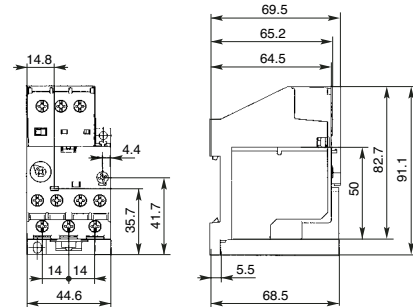

E16DU with A/AE9, A/AE12, A/AE16

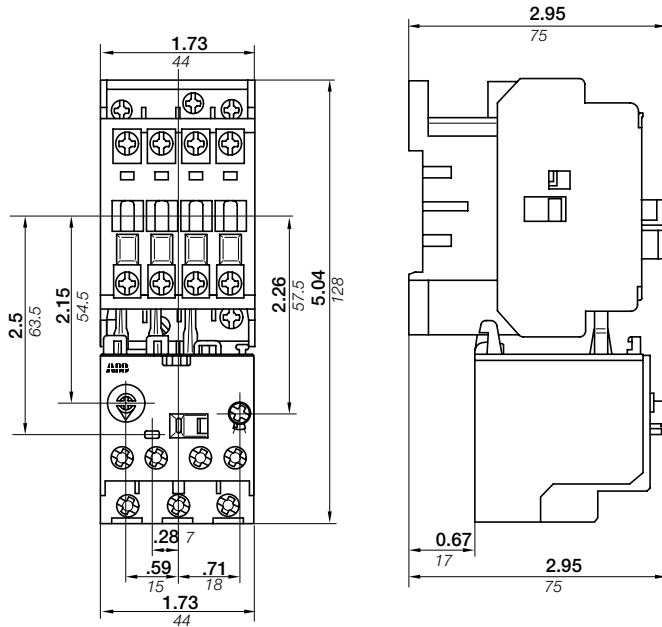

E16DU with B/BC6, B/BC7

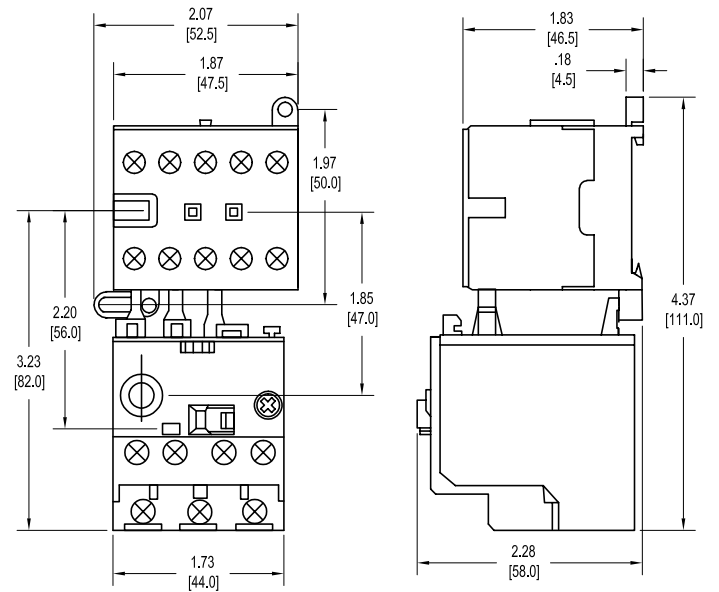

E200DU

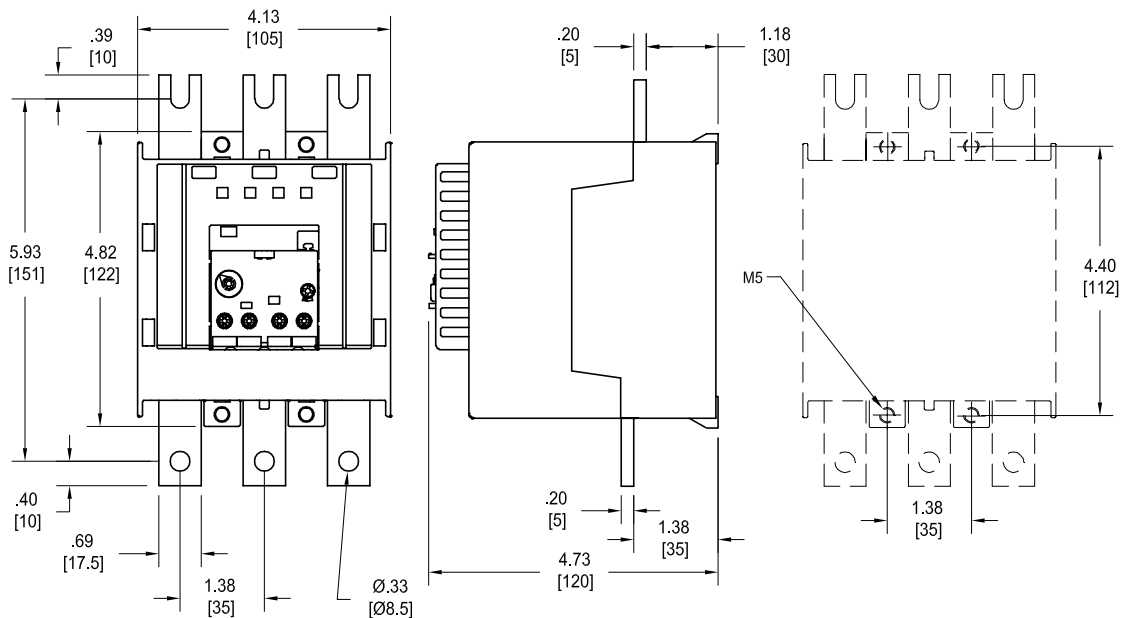

Approximate dimensions E320DU – E800DU

2

E320DU

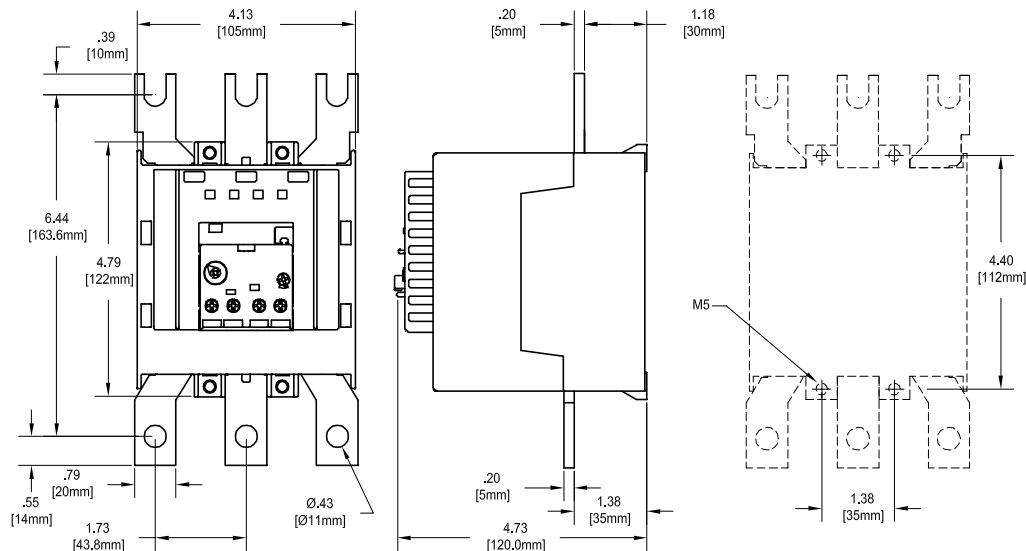

E500DU

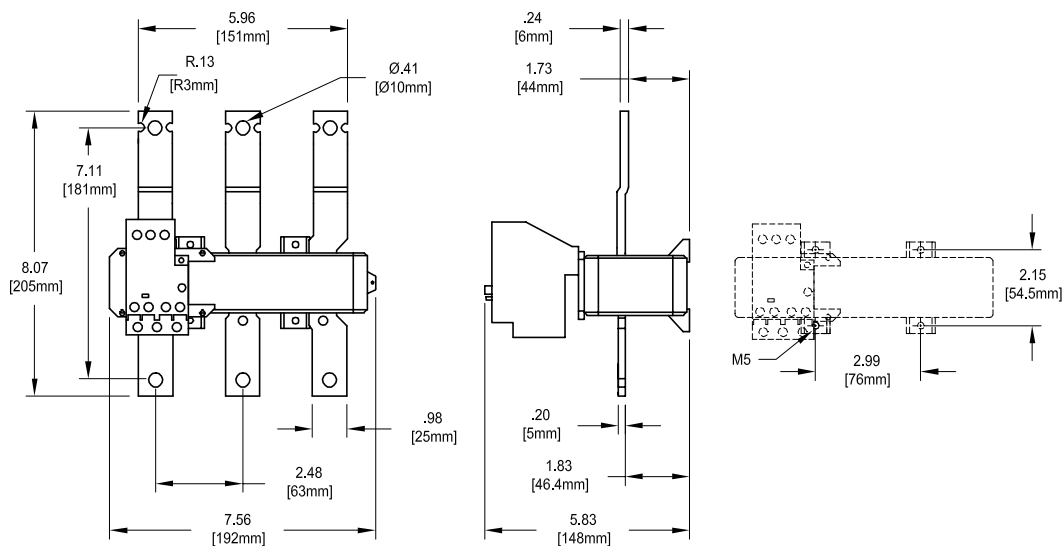

E800DU

